

DS-2CD2743G2-IZS

4 MP AcuSense Motorized Varifocal Dome Network Camera

AcuSense



Empowered by deep learning algorithms, Hikvision AcuSense technology brings human and vehicle targets classification alarms to front- and back-end devices. The system focuses on human and vehicle targets, vastly improving alarm efficiency and effectiveness.

- High quality imaging with 4 MP resolution
- Motorized varifocal lens for easy installation and monitoring
- Clear imaging against strong backlight due to 120 dB WDR technology
- Efficient H.265+ compression technology
- Water and dust resistant (IP67) and vandal resistant (IK10)
- Focus on human and vehicle targets classification based on deep learning



▪ Specification

| Camera | |
|-----------------------------|--|
| Image Sensor | 1/3" Progressive Scan CMOS |
| Min. Illumination | Color: 0.005 Lux @ (F1.6, AGC ON), 0 Lux with IR on |
| Shutter Speed | 1/3 s to 1/100,000 s |
| Slow Shutter | Yes |
| P/N | P/N |
| Wide Dynamic Range | 120 dB |
| Day & Night | ICR Cut |
| Angle Adjustment | Pan: 0° to 355°, tilt: 0° to 75°, rotate: 0° to 355° |
| Lens | |
| Lens Type & FOV | 2.8 to 12 mm, horizontal FOV 95.8° to 29.2°, vertical FOV 50.6° to 16.4°, diagonal FOV 114.6° to 33.4° |
| Aperture | F1.6 |
| Lens Mount | Ø14 |
| DORI | |
| DORI | 2.8 to 12 mm: D: 64 m to 200 m, O: 25.4 m to 79.4 m, R: 12.8 m to 40 m, I: 6.4 m to 20 m |
| Illuminator | |
| IR Range | Up to 40 m |
| Wavelength | 850 nm |
| Video | |
| Max. Resolution | 2688 × 1520 |
| Main Stream | 50Hz: 25 fps (2688 × 1520, 1920 × 1080, 1280 × 720) 60Hz: 30 fps (2688 × 1520, 1920 × 1080, 1280 × 720) |
| Sub Stream | 50Hz: 25 fps (640 × 480, 640 × 360) 60Hz: 30 fps (640 × 480, 640 × 360) |
| Third Stream | 50 Hz: 10 fps (1920 × 1080, 1280 × 720, 640 × 480, 640 × 360) 60 Hz: 10 fps (1920 × 1080, 1280 × 720, 640 × 480, 640 × 360) |
| Video Compression | Main stream: H.265/H.264/H.264+/H.265+ Sub-stream: H.265/H.264/MJPEG Third stream: H.265/H.264 |
| Video Bit Rate | 32 Kbps to 8 Mbps |
| H.264 Type | Baseline Profile/Main Profile/High Profile |
| H.265 Type | Main Profile |
| H.264+ | Main Stream supports |
| H.265+ | Main Stream supports |
| Bit Rate Control | CBR/VBR |
| Scalable Video Coding (SVC) | Yes |
| Region of Interest (ROI) | 1 fixed region for main stream and sub-stream |
| Audio | |
| Environment Noise Filtering | Yes |
| Audio Sampling Rate | 8 kHz/16 kHz/32 kHz/44.1 kHz/48 kHz |
| Audio Compression | G.711ulaw/G.711alaw/G.722.1/G.726/MP2L2/PCM/MP3/AAC |

| | |
|-------------------------------|---|
| Audio Bit Rate | 64Kbps(G.711ulaw/G.711alaw)/16Kbps(G.722.1)/16Kbps(G.726)/16Kbps-64Kbps(AAC)/32-192Kbps(MP2L2)/8-320Kbps(MP3) |
| Network | |
| Simultaneous Live View | Up to 6 channels |
| API | Open Network Video Interface (Profile S, Profile G), ISAPI, SDK |
| Protocols | TCP/IP, ICMP, HTTP, HTTPS, FTP, DHCP, DNS, DDNS, RTP, RTSP, NTP, UPnP, SMTP, IGMP, 802.1X, QoS, IPv6, UDP, Bonjour, SSL/TLS, PPPoE |
| User/Host | Up to 32 users. 3 user levels: administrator, operator and user |
| Security | Password protection, complicated password, HTTPS encryption, IP address filter, Security Audit Log, basic and digest authentication for HTTP/HTTPS, TLS 1.1/1.2, WSSE and digest authentication for Open Network Video Interface |
| Network Storage | MicroSD/SDHC/SDXC card (256 GB) local storage, and NAS(NFS, SMB/CIFS), auto network replenishment (ANR) |
| Client | iVMS-4200, Hik-Connect, Hik-Central |
| Web Browser | Plug-in required live view: IE 10, IE 11 Plug-in free live view : Chrome 57.0+, Firefox 52.0+ Local service: Chrome 57.0+, Firefox 52.0+ |
| Image | |
| Day/Night Switch | Day, Night, Auto, Schedule |
| Image Enhancement | BLC, HLC, 3D DNR |
| Image Parameters Switch | Yes |
| Image Settings | Rotate, mirror, privacy masks, saturation, brightness, contrast, sharpness, gain, white balance adjustable by client software or web browser |
| Interface | |
| Audio | -S: 1 input (line in), max. input amplitude: 3.3 vpp, input impedance: 4.7 K Ω , interface type: non-equilibrium; 1 output (line out), max. output amplitude: 3.3 vpp, output impedance: 100 Ω , interface type: non-equilibrium |
| Alarm | -S: 1 input, 1 output (max. 12 VDC, 30 mA) |
| On-board Storage | Built-in micro SD, up to 256 GB |
| Hardware Reset | Yes |
| Communication Interface | 1 RJ45 10M/100M self-adaptive Ethernet port |
| Event | |
| Basic Event | Motion detection (human and vehicle targets classification), video tampering alarm, exception |
| Face Detection | Yes |
| Deep Learning Function | |
| Perimeter Protection | Line crossing detection, intrusion detection Supports human and vehicle targets classification |
| General | |
| Linkage Method | Upload to FTP/memory card/NAS, notify surveillance center, trigger record, trigger capture, Email |

| | |
|----------------------------------|---|
| Web Client Language | 33 languages English, Russian, Estonian, Bulgarian, Hungarian, Greek, German, Italian, Czech, Slovak, French, Polish, Dutch, Portuguese, Spanish, Romanian, Danish, Swedish, Norwegian, Finnish, Croatian, Slovenian, Serbian, Turkish, Korean, Traditional Chinese, Thai, Vietnamese, Japanese, Latvian, Lithuanian, Portuguese (Brazil), Ukrainian |
| General Function | Anti-flicker, heartbeat, password reset via e-mail, pixel counter |
| Storage Conditions | -30 °C to 60 °C (-22 °F to 140 °F). Humidity 95% or less (non-condensing) |
| Startup and Operating Conditions | -30 °C to 60 °C (-22 °F to 140 °F). Humidity 95% or less (non-condensing) |
| Power Supply | 12 VDC ± 25%, reverse polarity protection PoE: 802.3af, Class 3 |
| Power Consumption and Current | 12 VDC, 0.88 A, max. 10.5 W PoE: (802.3af, 36 V to 57 V), 0.35 A to 0.22 A, max. 12.5 W |
| Power Interface | Ø5.5 mm coaxial power plug |
| Material | Upper cover and base: metal Bubble: plastic |
| Camera Dimension | Ø153.3 × 111.6 mm (Ø6.1" × 4.4") |
| Package Dimension | 244 × 174 × 173 mm (9.7" × 6.9" × 6.9") |
| Camera Weight | Approx. 880 g (1.9 lb.) |
| With Package Weight | Approx. 1419 g (3.1 lb.) |
| Approval | |
| EMC | FCC (47 CFR Part 15, Subpart B); CE-EMC (EN 55032: 2015, EN 61000-3-2: 2014, EN 61000-3-3: 2013, EN 50130-4: 2011 +A1: 2014); RCM (AS/NZS CISPR 32: 2015); IC (ICES-003: Issue 6, 2016); KC (KN 32: 2015, KN 35: 2015) |
| Safety | UL (UL 60950-1); CB (IEC 60950-1:2005 + Am 1:2009 + Am 2:2013); CE-LVD (EN 60950-1:2005 + Am 1:2009 + Am 2:2013); BIS (IS 13252(Part 1):2010+A1:2013+A2:2015) |
| Environment | CE-RoHS (2011/65/EU); WEEE (2012/19/EU); Reach (Regulation (EC) No 1907/2006) |
| Protection | IP67 (IEC 60529-2013), IK10 (IEC 62262:2002) |

▪ Available Model

DS-2CD2743G2-IZS (2.8 to 12 mm)

▪ Typical Application

Hikvision products are classified into three levels according to their anti-corrosion performance. Refer to the following description to choose for your using environment.

This model has NO SPECIFIC PROTECTION.

| Level | Description |
|----------------------|--|
| Top-level protection | Hikvision products at this level are equipped for use in areas where professional anti-corrosion protection is a must. Typical application scenarios include coastlines, docks, chemical plants, and more. |
| Moderate protection | Hikvision products at this level are equipped for use in areas with moderate anti-corrosion |





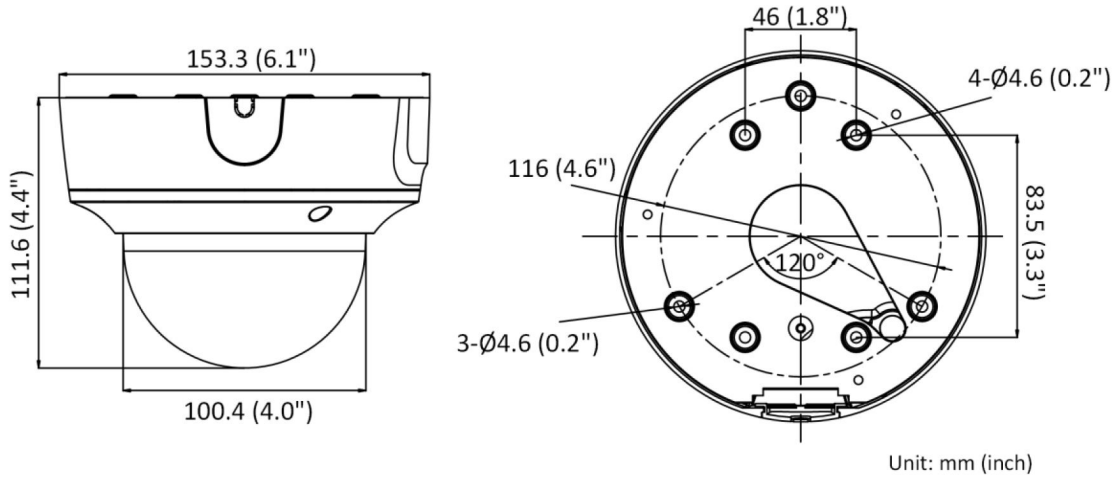

| | |
|------------------------|--|
| | demands. Typical application scenarios include coastal areas about 2 kilometers (1.24 miles) away from coastlines, as well as areas affected by acid rain. |
| No specific protection | Hikvision products at this level are equipped for use in areas where no specific anti-corrosion protection is needed. |

▪ **Dimension**



▪ **Accessory**

▪ **Optional**

| | | | | |
|---|---|---|---|---|
| DS-1280ZJ-DM55 Junction Box | DS-1473ZJ-155B Wall Mount | DS-1475ZJ-SUS Vertical Pole Mount | DS-1476ZJ-SUS Corner Mount | DS-1473ZJ-155 Wall Mount |
|  |  |  |  |  |
| DS-1227ZJ-DM44 Pendant Mount | DS-1471ZJ-155 Pendant Mount | | | |
|  |  | | | |